



# TSH24

## HIGH PERFORMANCE QUAD BIPOLAR OPERATIONAL AMPLIFIER

- HIGH GAIN BANDWIDTH PRODUCT :  
**25MHz**
- HIGH SLEW RATE : **15V/μs**
- SINGLE OR DUAL SUPPLY OPERATION :  
**3V TO 30V** ( $\pm 1.5V$  to  $\pm 15V$ )
- LOW VOLTAGE NOISE : **14nV/√Hz**
- NO PHASE INVERSION
- ESD TOLERANCE : 2kV
- LATCH-UP IMMUNITY
- **SPICE MACROMODEL** INCLUDED IN THIS SPECIFICATION

### DESCRIPTION

The TSH24 is a quad bipolar operational amplifier offering a single supply operation from 3V to 30V with very good performances : medium speed (25MHz), unity gain stability and low noise.

The TSH24 is therefore an enhanced replacement of standard dual operational amplifiers.

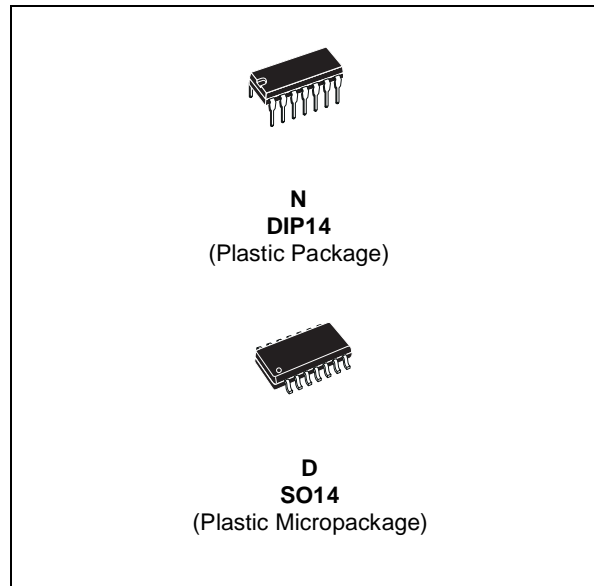

### ORDER CODE

Part Number	Temperature Range	Package	
		N	D
TSH24I	-40°C, +125°C	•	•

N = Dual in Line Package (DIP)  
D = Small Outline Package (SO) - also available in Tape & Reel (DT)

### PIN CONNECTIONS (top view)

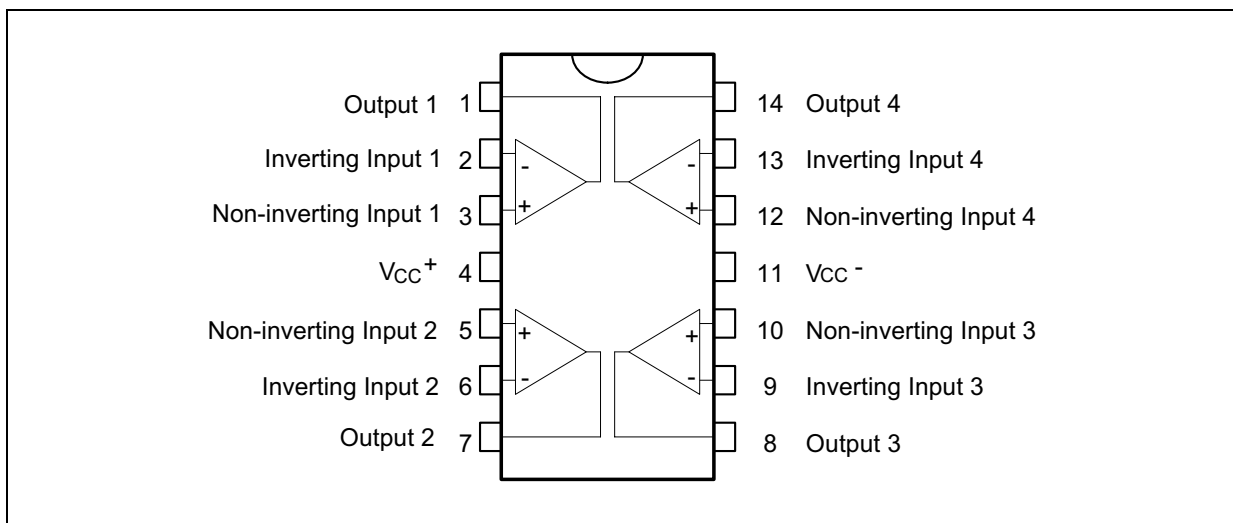

**SCHEMATIC DIAGRAM (1/4 TSH24)**

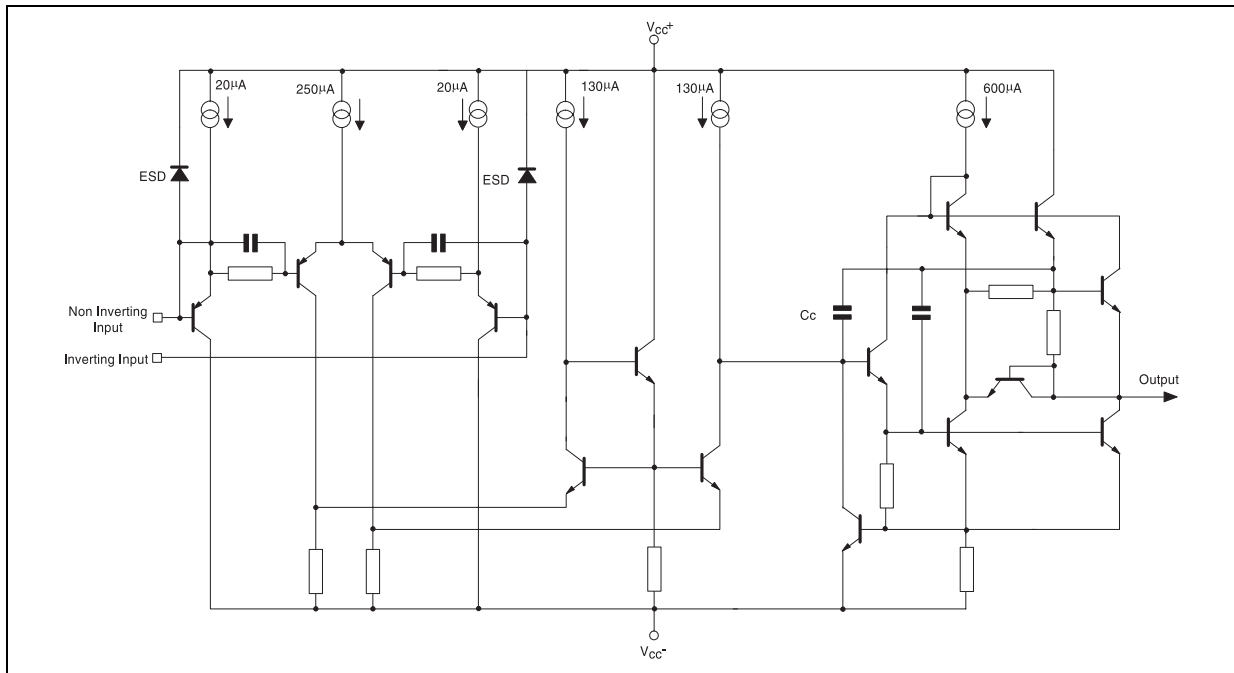

**ABSOLUTE MAXIMUM RATINGS**

Symbol	Parameter	Value	Unit
$V_{CC}$	Supply Voltage	$\pm 18$ to 36	V
$V_{id}$	Differential Input Voltage <sup>1)</sup>	$\pm 36$	V
$V_i$	Input Voltage (see note 1)	$\pm 18$	V
	Output Short-circuit Duration <sup>2)</sup>	Infinite	
$T_{oper}$	Operating Free-Air Temperature Range	-40 to +125	°C
$T_j$	Maximum Junction Temperature	+150	°C
$T_{stg}$	Storage Temperature Range	-65 to +150	°C
$P_{tot}$	Maximum Power Dissipation (see note 2)	500	mW

1. Either or both input voltages must not exceed the magnitude of  $V_{CC}^+$  or  $V_{CC}^-$
2. Power dissipation must be considered to ensure maximum junction temperature ( $T_j$ ) is not exceeded

**OPERATING CONDITIONS**

Symbol	Parameter	Value	Unit
$V_{CC}$	Supply Voltage	3 to 30	V
$V_{id}$		0	mV
$A_{vd}$	$R_L = 2k\Omega$	100	dB
$I_{cc}$	No load, each amplifier	2	mA
$V_{icm}$		-15.2 to 13.8	V
$V_{OH}$	$R_L = 2k\Omega$	+13.9	V
$V_{OL}$	$R_L = 2k\Omega$	-13.9	V
$I_{sink}$	$V_o = 0V$	40	mA
$I_{source}$	$V_o = 0V$	40	mA
GBP	$R_L = 2k\Omega, C_L = 100pF$	34	MHz
SR	$R_L = 2k\Omega, C_L = 100pF$	10	V/ $\mu s$
$\phi_m$	$R_L = 2k\Omega, C_L = 100pF$	36	Degrees
$\phi_m$	$R_L = 2k\Omega, C_L = 300pF$	26	Degrees

**ELECTRICAL CHARACTERISTICS**
 $V_{CC}^+ = 15V$ ,  $V_{CC}^- = -15V$ ,  $T_{amb} = 25^\circ C$  (unless otherwise specified)

Symbol	Parameter	Min.	Typ.	Max.	Unit
$V_{io}$	Input Offset Voltage ( $V_{ic} = 0V$ , $V_o = 0V$ ) $V_{CC}^+ = +15V$ , $V_{CC}^- = -15V$ $T_{min} \leq T_{amb} \leq T_{max}$ $V_{CC}^+ = +5V$ , $V_{CC}^- = 0V$			2.5 3.5 2.5	mV
$\Delta V_{io}$	Input Offset Voltage Drift ( $V_{ic} = 0V$ , $V_o = 0V$ , $T = -40, +85^\circ C$ )		2		$\mu V/^\circ C$
$I_{io}$	Input Offset Current ( $V_{ic} = 0V$ , $V_o = 0V$ )		3	65	nA
$I_{ib}$	Input Bias Current ( $V_{ic} = 0V$ , $V_o = 0V$ )		100	650	nA
$V_{icm}$	Common Mode Input Voltage Range		$V_{CC}^-$ to $V_{CC}^+ - 1.8$		V
$A_{vd}$	Large Signal Voltage Gain ( $R_L = 2k\Omega$ , $V_o = 0V$ to $+10V$ ) $T_{min} \leq T_{amb} \leq T_{max}$	32 20	100		V/mV
$\pm V_{opp}$	Output Voltage Swing ( $V_{id} = \pm 1V$ ) $V_{CC}^+ = +15V$ , $V_{CC}^- = -15V$ $R_L = 2k\Omega$ $V_{OH}$ $V_{OL}$ $R_L = 10k\Omega$ $V_{OH}$ $V_{OL}$ $V_{CC}^+ = +5V$ , $V_{CC}^- = 0V$ $R_L = 2k\Omega$ $V_{OH}$ $V_{OL}$	13.4 13.4 3.7	13.9 14 0.15	-13.5 -14.1 0.2	V
$I_o$	Output Short Circuit Current ( $V_{id} = \pm 1V$ , $V_o = 0V$ ) Source Sink	25 25	37 37		mA
CMR	Common Mode Rejection Ratio ( $V_{ic} = -15V$ to $+13.2V$ )	80	100		dB
SVR	Supply Voltage Rejection Ratio $V_{CC}^+/V_{CC}^- = +15V/-15V$ to $+5V/-5V$	90	105		dB
$I_{CC}$	Supply Current ( $V_o = 0V$ , no load, each amplifier) $V_{CC}^+ = +15V$ , $V_{CC}^- = -15V$ $T_{min} \leq T_{amb} \leq T_{max}$ $V_{CC}^+ = +5V$ , $V_{CC}^- = 0V$		2.15	2.75 3 2.75	mA
SR	Slew Rate ( $V_i = -10V$ to $+10V$ , $C_L = 100pF$ , $R_L = 2k\Omega$ , $A_V = +1$ )	8	15		V/ $\mu s$
GBP	Gain Bandwidth Product ( $f = 100kHz$ , $R_L = 2k\Omega$ , $C_L = 100pF$ )	17	25		MHz
B	Unity Gain Bandwidth (Open loop)		5		MHz
$\phi_m$	Phase Margin $R_L = 2k\Omega$ $R_L = 2k\Omega$ , $C_L = 100pF$		50 40		Degrees
$e_n$	Equivalent Input Noise Voltage ( $R_s = 100\Omega$ , $f = 1kHz$ )		14		$\frac{nV}{\sqrt{Hz}}$
$V_{o1}/V_{o2}$	Channel Separation ( $f = 20Hz$ to $20kHz$ )		120		dB
THD	Total Harmonic Distortion ( $V_{CC} = \pm 15V$ , $f = 1kHz$ , $A_{VCL} = 20dB$ , $R_L = 600\Omega$ , $V_o = 3V_{rms}$ )		0.003		%

**MACROMODEL**

\*\* Standard Linear Ics Macromodels, 1993.

CONNECTIONS :

- \* 1 INVERTING INPUT
- \* 2 NON-INVERTING INPUT
- \* 3 OUTPUT
- \* 4 POSITIVE POWER SUPPLY
- \* 5 NEGATIVE POWER SUPPLY

.SUBCKT TSH24 1 3 2 4 5 (analog)

\*\*\*\*\*  
.MODEL MDTH D IS=1E-8 KF=7.976636E-15  
CJO=10F

\* INPUT STAGE

CIP 2 5 1.200000E-11  
CIN 1 5 1.200000E-11  
EIP 10 5 2 5 1  
EIN 16 5 1 5 1  
RIP 10 11 1.083333E+00  
RIN 15 16 1.083333E+00  
RIS 11 15 8.942641E+00  
DIP 11 12 MDTH 400E-12  
DIN 15 14 MDTH 400E-12  
VOFP 12 13 DC 0  
VOFN 13 14 DC 0  
IPOL 13 5 2.400000E-04  
CPS 11 15 10.5E-09  
DINN 17 13 MDTH 400E-12  
VIN 17 5 -0.200000E+00  
DINR 15 18 MDTH 400E-12  
VIP 4 18 1.800000E+00  
FCP 4 5 VOFP 7.750000E+00  
FCN 5 4 VOFN 7.750000E+00  
FIBP 2 5 VOFN 5.000000E-04  
FIBN 5 1 VOFP 5.000000E-04

\* AMPLIFYING STAGE

FIP 5 19 VOFP 6.708333E+02  
FIN 5 19 VOFN 6.708333E+02  
GVNEG 5 19 5 13 1.395908E-05  
GVPOS 5 19 4 13 1.395908E-05  
RG1 19 5 8.056996E+04  
RG2 19 4 8.056996E+04  
CC 19 29 1.100000E-08  
HZTP 30 29 VOFP 6.545046E+01  
HZTN 5 30 VOFN 6.545046E+01  
DOPM 19 22 MDTH 400E-12  
DONM 21 19 MDTH 400E-12  
HOPM 22 28 VOUT 4.054054E+03  
VIPM 28 4 1.500000E+02  
HONM 21 27 VOUT 4.054054E+03  
VINM 5 27 1.500000E+02  
RPM1 5 80 1E+06  
RPM2 4 80 1E+06  
GAVPH 5 82 19 80 6.00E-07  
RAVPHGH 82 4 3333222  
RAVPHGB 82 5 3333222  
RAVPHDH 82 83 1000000  
RAVPHDB 82 84 1000000  
CAVPHH 4 83 0.12243E-12  
CAVPHB 5 84 0.12243E-12  
EOUT 26 23 82 5 1  
VOUT 23 5 0  
ROUT 26 3 2.472597E+01  
COUT 3 5 1.000000E-12  
DOP 19 25 MDTH 400E-12  
VOP 4 25 1.824860E+00  
DON 24 19 MDTH 400E-12  
VON 24 5 1.824860E+00  
.ENDS

## APPLICATIONS INFORMATION

### TSH24 IN COMPARATOR APPLICATION

The TSH24 is a quad high performances operational amplifier featuring speed of 30MHz and single supply operation from 3V to 30V.

Most of operational amplifiers are not suited for comparator use because of low transition speed, output signal incompatible with standard logics level and mainly, phase inversion.

The phase inversion occurs when a strong differential signal is applied to the device inputs. The output level is then inverted and shows a wrong logic state. The TSH24 does not present this problematic behaviour.

Displayed curves below show the device response in standard comparator configuration without external components.

Transition speed : Typical transition speed under a single 5V supply voltage is about  $2\mu\text{s}$  from 50mV overdrive.  $V_{OH}$  min. is 3.7V and  $V_{OL}$  max. is 0.2V ( $2\text{k}\Omega$  load) making it compatible with standard logic families.

Figures 3 & 4 show output signal transition for a 50mV and 250mV input signal overdrive respectively of  $3\mu\text{s}$  and  $1\mu\text{s}$ .

**Figure 1** : Basic comparator application

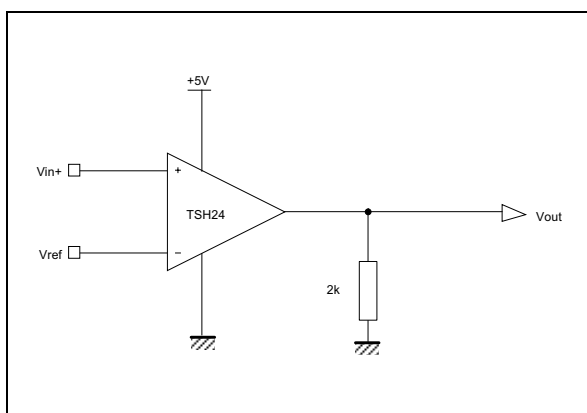

**Figure 2** : Operating conditions

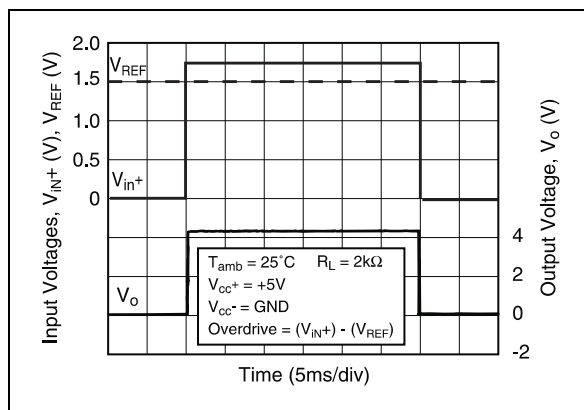

**Figure 3** : Transition speed@ 50mV overdrive

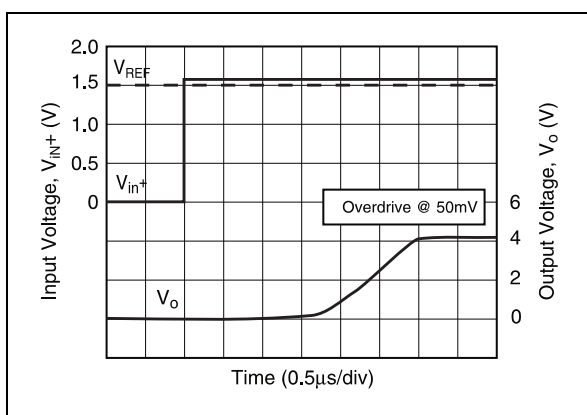

**Figure 4** : Transition speed@ 250mV overdrive

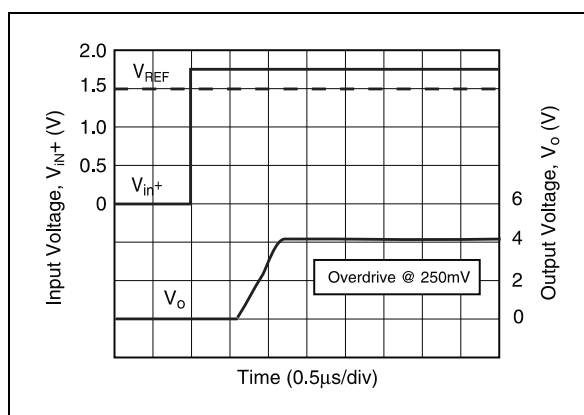

**PHASE INVERSION**

At high differential input voltage, the TSH24 keeps the right output level thanks to its specific input structures.

The advantage is obvious on the following figures and can be also an advantage in linear use when saturation might occur.

**Figure 5** : Behaviour with TSH24

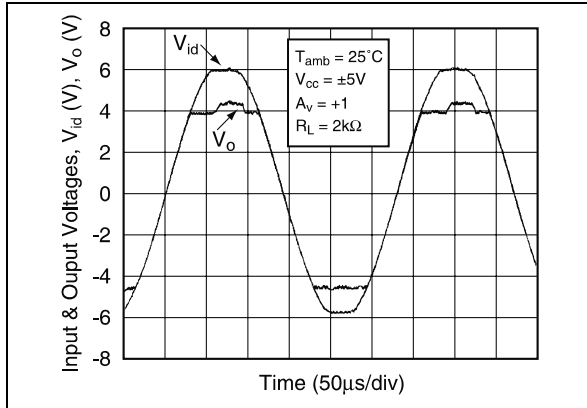
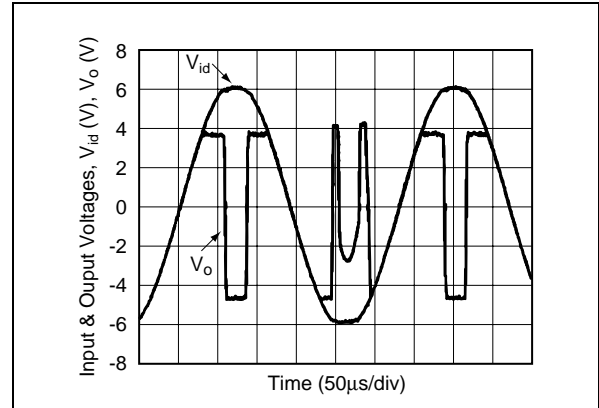
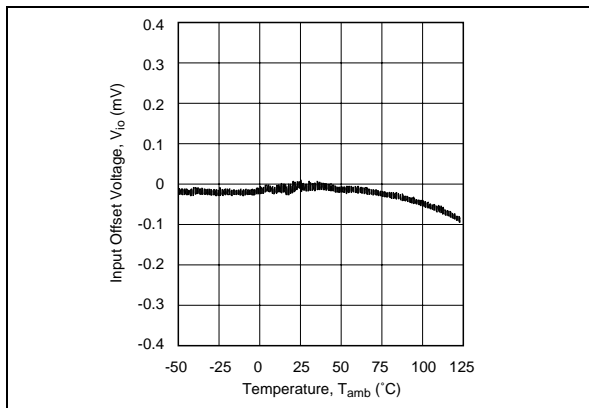

Figure 5 & 6 show the behaviour in follower stage with saturation output of TSH24 versus 15MHz standard operational amplifier.

**Figure 6** : Saturation behaviour with 15MHz standard operational amplifier



**INPUT OFFSET VOLTAGE DRIFT VERSUS TEMPERATURE**



**SUPPLY CURRENT VERSUS SUPPLY VOLTAGE (ALL OP-AMPS)**

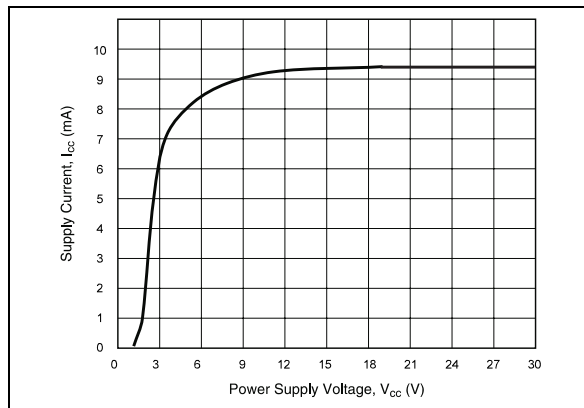

**SINK CURRENT**

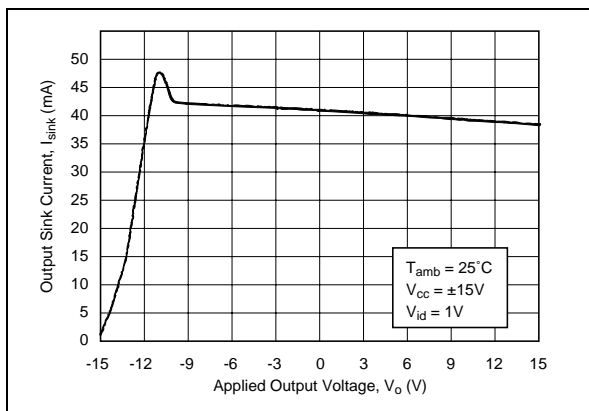

**SOURCE CURRENT**

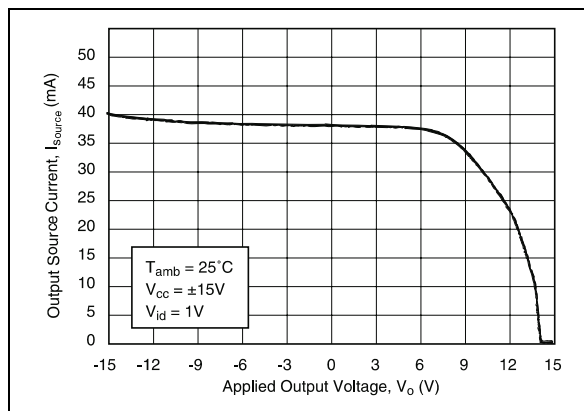

**SLEW RATE @ 30V**

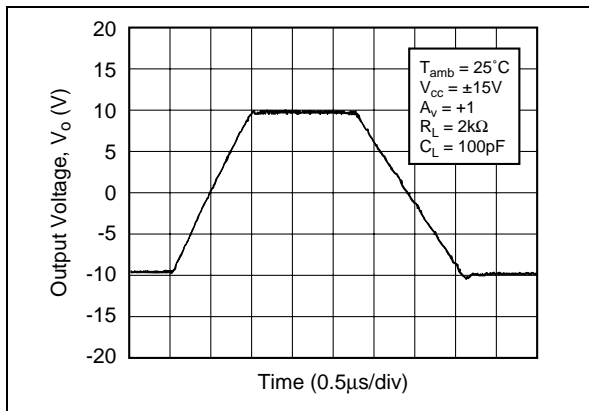

**SLEW RATE @ 3V**

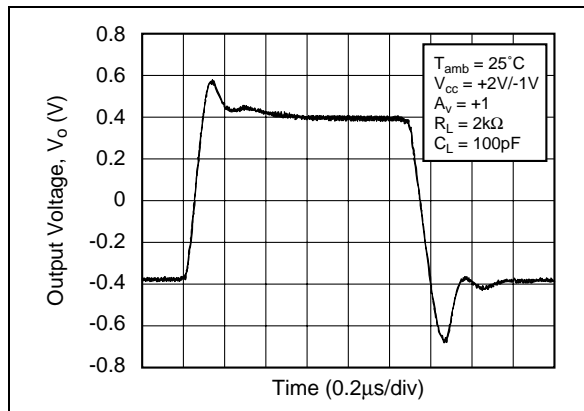

**LARGE SIGNAL VOLTAGE GAIN @ NO LOAD**

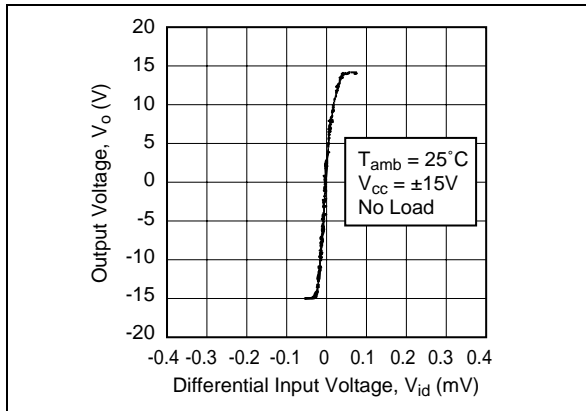

**LARGE SIGNAL VOLTAGE GAIN @ LOAD**

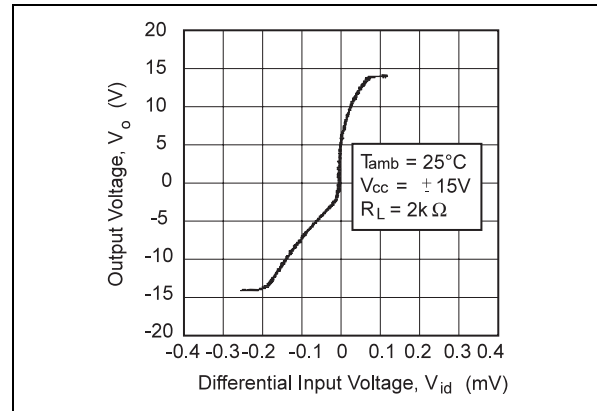

**SMALL SIGNAL RESPONSE @ 30V**

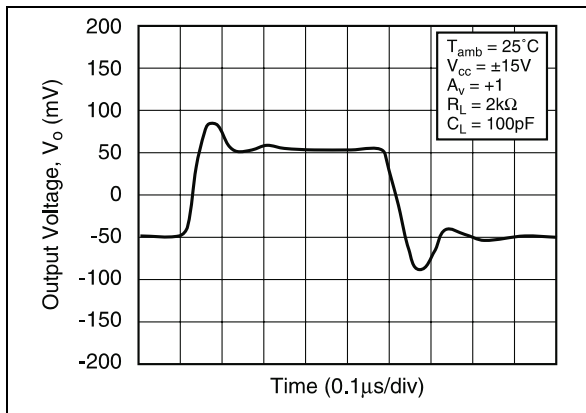

**SMALL SIGNAL RESPONSE @ 3V**

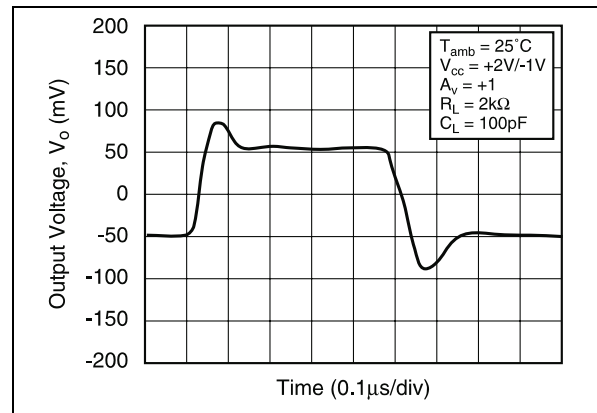

**UNITY GAIN BANDWIDTH @ 30V**

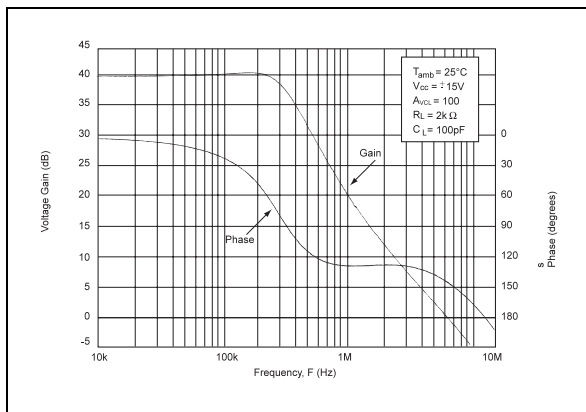

**UNITY GAIN BANDWIDTH @ 3V**

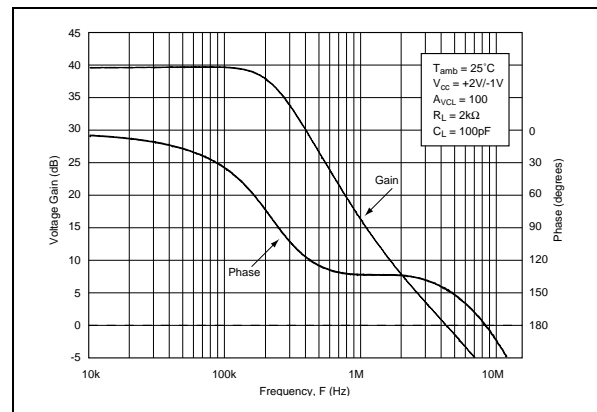



## CLOSED LOOP BANDWIDTH @ 30V

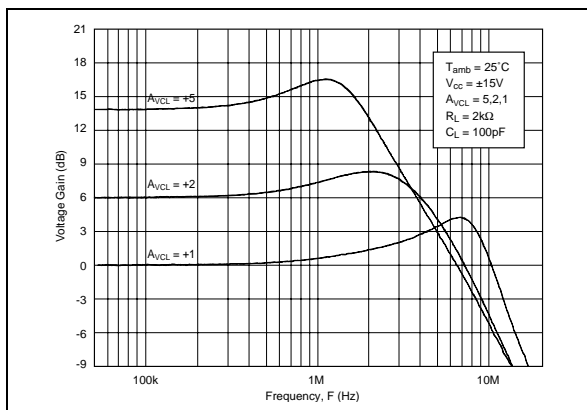

## CLOSED LOOP BANDWIDTH @ 3V

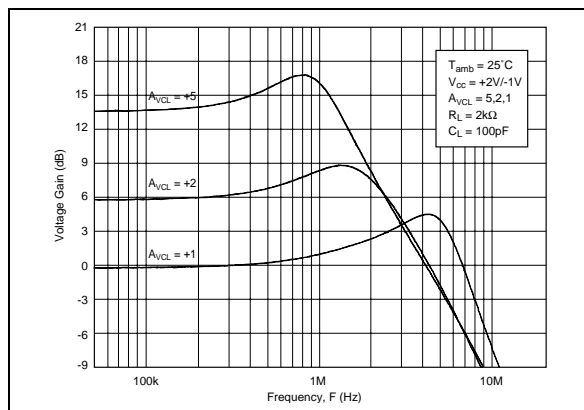

# TSH24

## PACKAGE MECHANICAL DATA

14 PINS - PLASTIC DIP

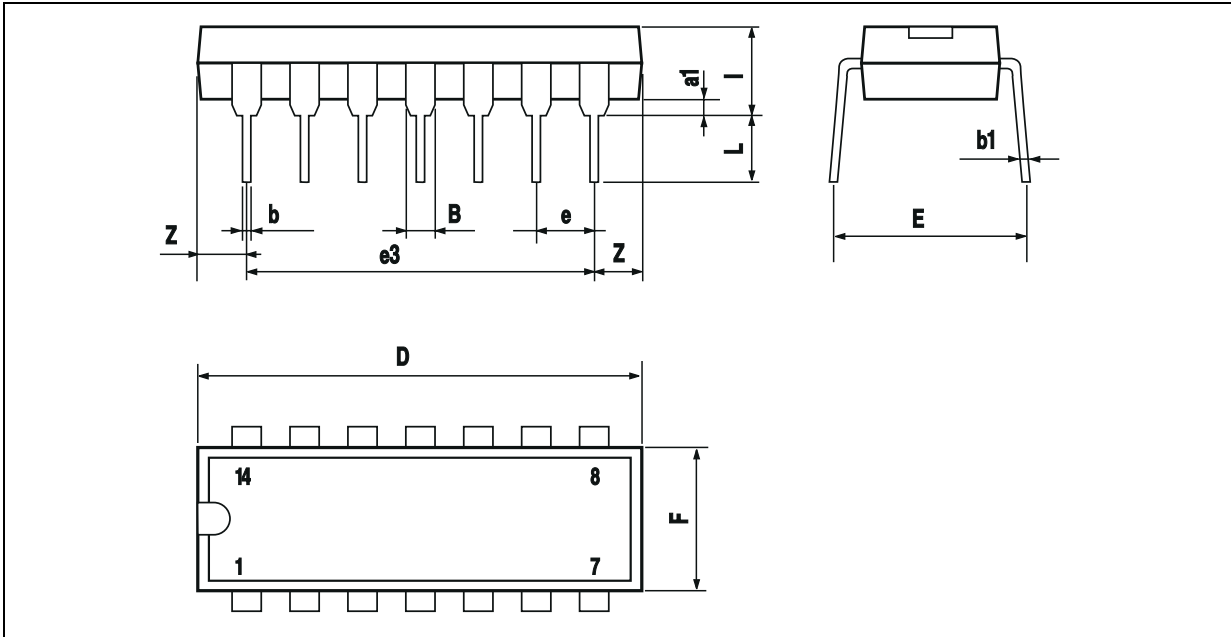

Dim.	Millimeters			Inches		
	Min.	Typ.	Max.	Min.	Typ.	Max.
a1	0.51			0.020		
B	1.39		1.65	0.055		0.065
b		0.5			0.020	
b1		0.25			0.010	
D			20			0.787
E		8.5			0.335	
e		2.54			0.100	
e3		15.24			0.600	
F			7.1			0.280
i			5.1			0.201
L		3.3			0.130	
Z	1.27		2.54	0.050		0.100

**PACKAGE MECHANICAL DATA**  
14 PINS - PLASTIC MICROPACKAGE (SO)

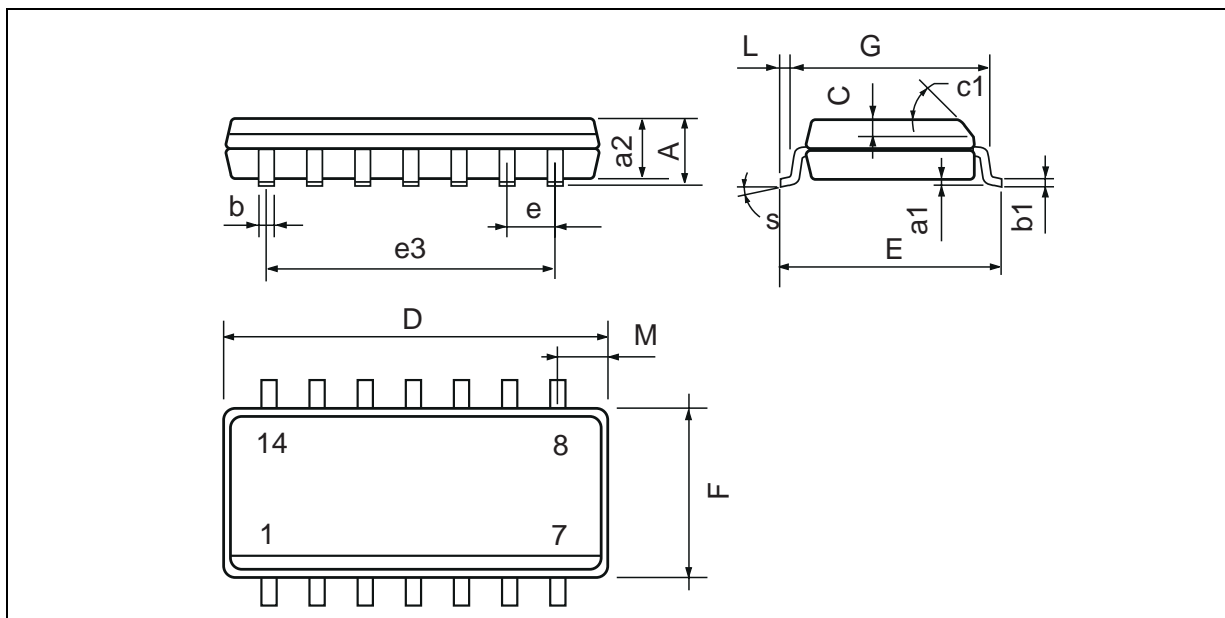

Dim.	Millimeters			Inches		
	Min.	Typ.	Max.	Min.	Typ.	Max.
A			1.75			0.069
a1	0.1		0.2	0.004		0.008
a2			1.6			0.063
b	0.35		0.46	0.014		0.018
b1	0.19		0.25	0.007		0.010
C		0.5			0.020	
c1	45° (typ.)					
D (1)	8.55		8.75	0.336		0.344
E	5.8		6.2	0.228		0.244
e		1.27			0.050	
e3		7.62			0.300	
F (1)	3.8		4.0	0.150		0.157
G	4.6		5.3	0.181		0.208
L	0.5		1.27	0.020		0.050
M			0.68			0.027
S	8° (max.)					

Note : (1) D and F do not include mold flash or protrusions - Mold flash or protrusions shall not exceed 0.15mm (.066 inc) ONLY FOR DATA BOOK.

Information furnished is believed to be accurate and reliable. However, STMicroelectronics assumes no responsibility for the consequences of use of such information nor for any infringement of patents or other rights of third parties which may result from its use. No license is granted by implication or otherwise under any patent or patent rights of STMicroelectronics. Specifications mentioned in this publication are subject to change without notice. This publication supersedes and replaces all information previously supplied. STMicroelectronics products are not authorized for use as critical components in life support devices or systems without express written approval of STMicroelectronics.

© The ST logo is a registered trademark of STMicroelectronics

© 2001 STMicroelectronics - Printed in Italy - All Rights Reserved  
STMicroelectronics GROUP OF COMPANIES

Australia - Brazil - Canada - China - Finland - France - Germany - Hong Kong - India - Israel - Italy - Japan - Malaysia  
Malta - Morocco - Singapore - Spain - Sweden - Switzerland - United Kingdom - United States

© <http://www.st.com>